

PERI Rental Criteria 租賃準則

VARIO Accessories

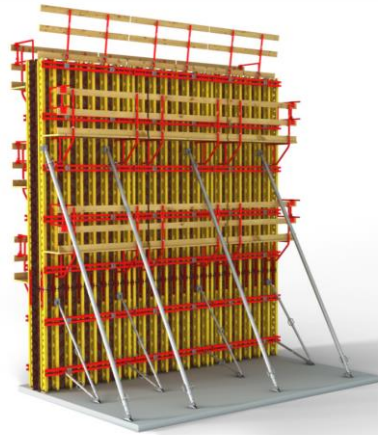

派利台灣有限公司
 台北市信義區基隆路一段
 163號10樓之一
 電話：02-3765-1211
 傳真：02-3765-1221
info@peri.tw



內容	頁數	修訂	日期 初始版本	頁數
Hook Straps 吊鉤帶	2	New version 新版本	01/2018 fw	
Crane Hook-2 吊鉤-2	17			
Tie Yoke Head SRU 背撐頭 SRU	20			
Various Accessories 各式配件	22			
Glossary Icons 圖示對照表	32			

PERI Rental Criteria 租賃準則

VARIO Accessories



Hook Strap 吊鉤帶 24-100/120 | 24-140/160

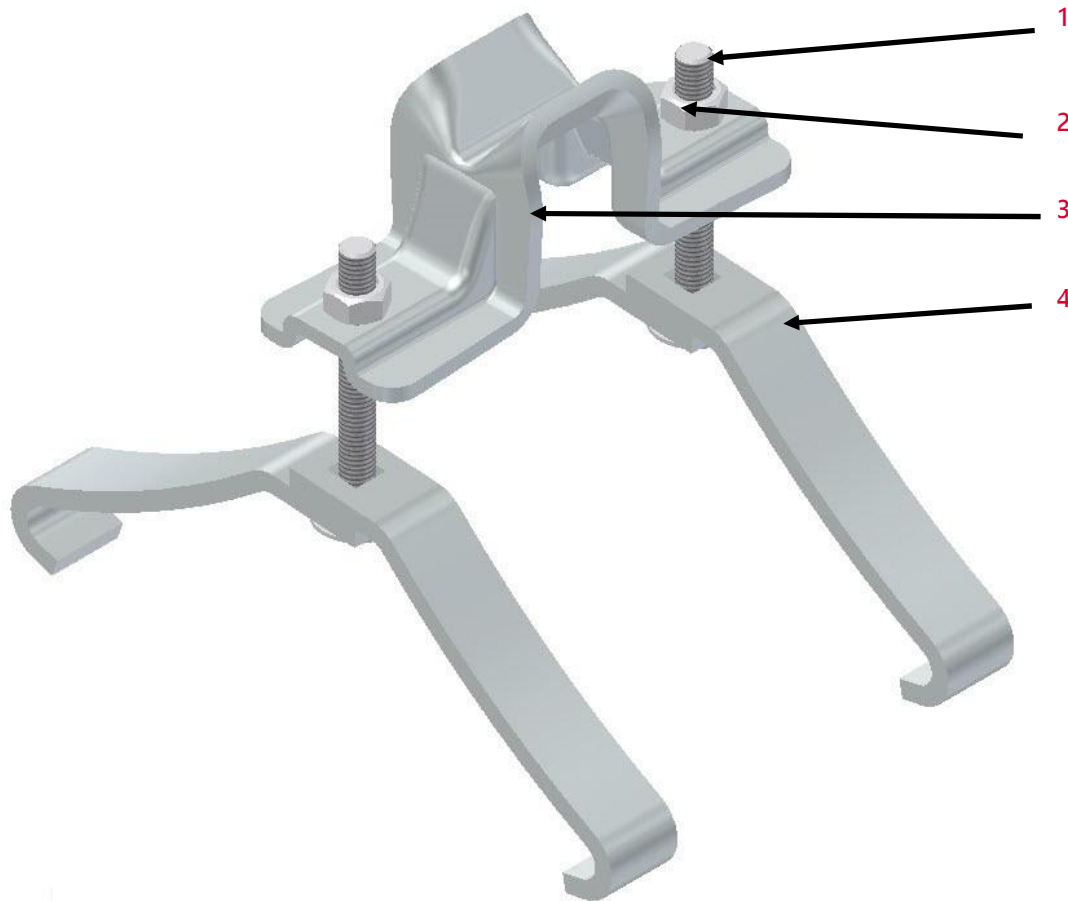

















No.	Name 名稱	Article number 品項編號
1	Bolt 螺栓	126228
2	Nut 螺帽	024090
3	Horizontal bracket 水平支架	710253
4	Tension bracket 24-100/120 拉力支架 24-100/120	024040
4	Tension bracket 24-140/160 拉力支架 24-140/160	722690

Valid for 適用產品	Article number 品項編號
Hook Strap 24-100/120	024070
Hook Strap 24-140/160	

PERI Rental Criteria 租賃準則

VARIO Accessories



Hook Strap 吊鉤帶 24-100/120 24-140/160	描述	說明	收費說明	類型
	09.01 Bolt Nut 螺栓 螺帽			
	■ Missing 遺失			
	■ Or bent 或彎曲			
	09.02 Tension bracket 拉力支架			
	■ Missing 遺失			
	■ Or bent 或彎曲			

Hook Strap 吊鈎帶 24-100/120 24-140/160	描述	說明	收費說明	類型
--	----	----	------	----



09.03 Rusty 生鏽

- Degree of rust A; B or C
生鏽程度 A、B或C
- Degree of rust > C
生鏽程度 > C



09.04 Soiled heavily 嚴重汙損

- If removable 如可清除
- Or if not and parts replaceable
或如不可清除，而零件可替換
- Or if parts not replaceable
或如零件無法替換



PERI Rental Criteria 租賃準則

VARIO Accessories



Hook Strap Uni HBU, 吊鉤帶 HBU

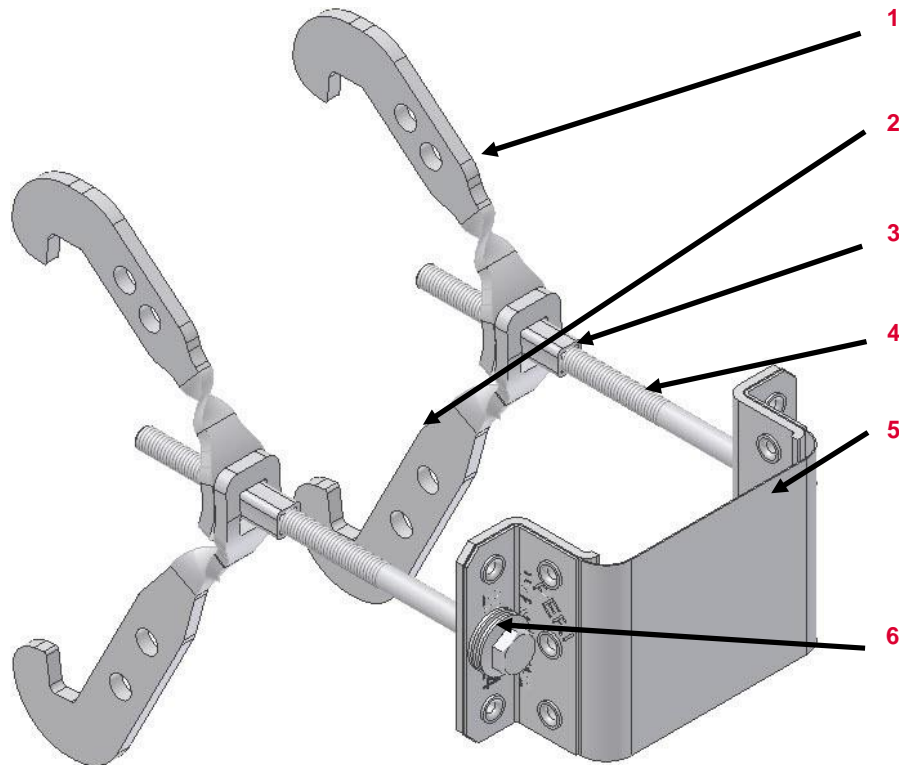

No.	Name 名稱	Article number 品項編號
1	Hook 123 鉤子 123	103840
2	Hook 160 鉤子 160	103842
3	Sleeve 套管	103844
4	Bolt 螺栓	
5	Strap 金屬帶	
6	Disk spring 墊圈	109870

Valid for 適用產品	Article number 品項編號
Hook Strap Universal HBU 24-28	103845
Hook Strap Universal HBU 20-24	104931
Hook Strap Universal HBU 16-26 U200	111806
Hook Strap Universal Double 24-28	104096
Hook Strap Universal Double 20-24	104930
Hook Strap MPB 24/GT24	111000

Hook Strap Uni HBU, 吊鉤帶 HBU	描述	說明	收費說明	類型
	<p>09.05 Complete Hook strap soiled with concrete 整支吊鉤帶都沾滿混凝土</p>			
	<p>09.06 Bolt soiled with concrete 螺栓沾滿混凝土</p>			

Hook Strap Uni HBU, 吊鉤帶 HBU	描述	說明	收費說明	類型
	<p>09.07 Strap soiled with concrete 金屬帶沾滿混凝土</p> <ul style="list-style-type: none"> ■ Screws can be tighten 螺絲可以被鎖緊 ■ Or soiled heavily 或嚴重汙損 	<p>✓</p> <p>⚙️</p>	<p>🚫</p> <p>📄</p>	<p>👁️</p> <p>⚙️</p>
	<p>09.08 Strap bent 金屬帶彎曲</p>	<p>⚙️</p>	<p>📄</p>	<p>⚙️</p>















Hook Strap Uni HBU, 吊鉤帶 HBU	描述	說明	收費說明	類型
	<p>09.09 Bolt bent 螺栓彎曲</p>			
	<p>09.10 Rust 生鏽</p> <ul style="list-style-type: none"> ■ At the bolts (bolts not movable) 在螺栓上 (螺栓無法移動) ■ Degree of rust until class C 在生鏽程度 C 以下 ■ Degree of rust D 生鏽程度 D 	 	 	

Hook Strap Uni HBU, 吊鉤帶 HBU	描述	說明	收費說明	類型
	<p>09.11 Strap bent 金屬帶彎曲</p> <ul style="list-style-type: none"> ■ Smooth bent 可撫平的彎曲 ■ Or kink 或扭結 	<p>✓</p> <p>⚙️</p>	<p>☰</p> <p>☰</p>	<p>👁️</p> <p>⚙️</p>
	<p>09.12 Crack in strap 金屬帶破裂</p>	<p>⚙️</p>	<p>☰</p>	<p>⚙️</p>

PERI Rental Criteria 租賃準則

VARIO Accessories



Hook Strap Uni HBU, 吊鉤帶 HBU	描述	說明	收費說明	類型
	09.13 Nail holes 釘孔	<ul style="list-style-type: none"> ■ ≤25 % material loss ≤25 % 材料損失 		
	<ul style="list-style-type: none"> ■ Or > 25 % material loss 或 > 25 % 材料損失 			
	<ul style="list-style-type: none"> ■ Or holes > Ø 5 mm 或孔洞 > Ø 5 mm 			
	09.14 Dent in strap 金屬帶凹痕	<ul style="list-style-type: none"> ■ ≤Ø 2 cm 		
	<ul style="list-style-type: none"> ■ Or > Ø 2 cm 			

Hook Strap HB, 吊鉤帶 HB

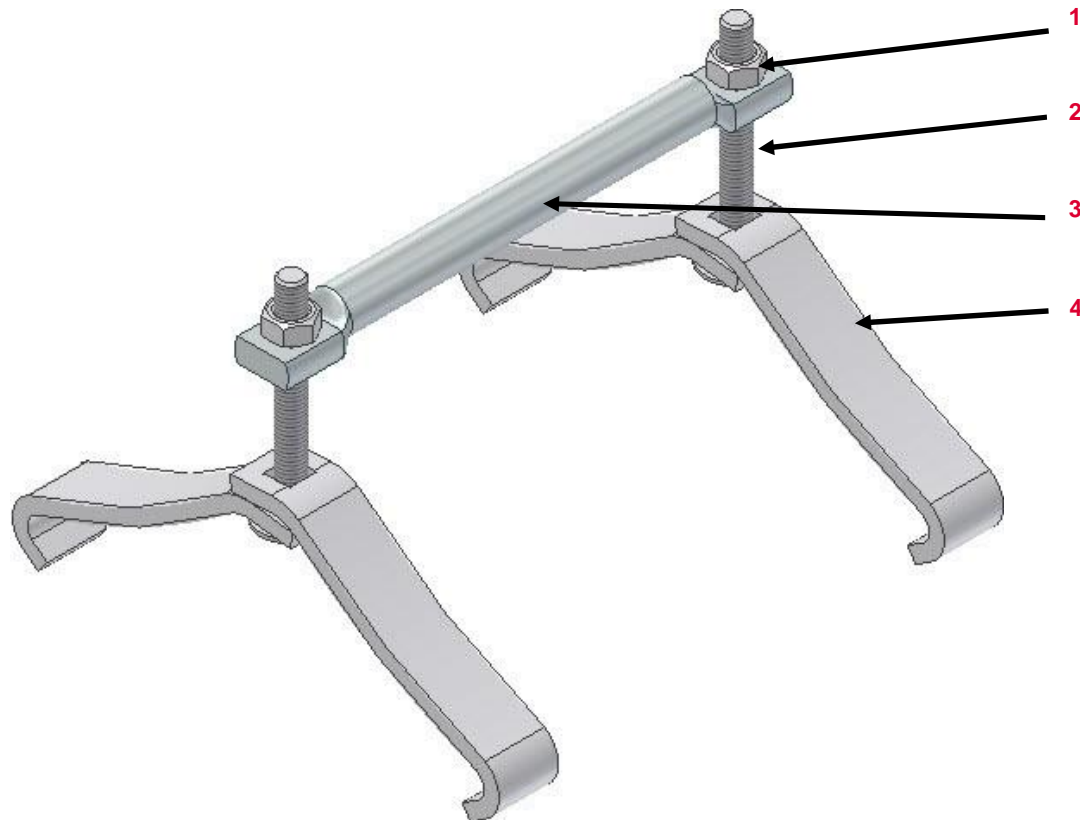

No.	Name 名稱	Article number 品項編號
1	Nut 螺母	024090
2	Bolt 螺栓	
3	Horizontal bracket 水平支架	726041
4	Hook HB HB 鉤子	024040

Valid for 適用產品	Article number 品項編號
Hook Strap HB	024110
Cross Strap HB	024860
Double Hook Strap DHB	024170

PERI Rental Criteria 租賃準則

VARIO Accessories



Hook Strap HB, 吊鉤帶 HB	描述	說明	收費說明	類型
-----------------------	----	----	------	----



09.15 Bolts | Nuts | Hooks
螺柱 | 螺母 | 鉤子

- Missing 遺失
- Or damaged through force 或受外力破壞
- Or soiled 或污損



09.16 Horizontal bracket 水平支架

- Missing 遺失
- Or damaged through force 或受外力破壞
- Or soiled 或污損



PERI Rental Criteria 租賃準則

VARIO Accessories



Hook Strap for T20, T20 吊鉤帶 (024880)

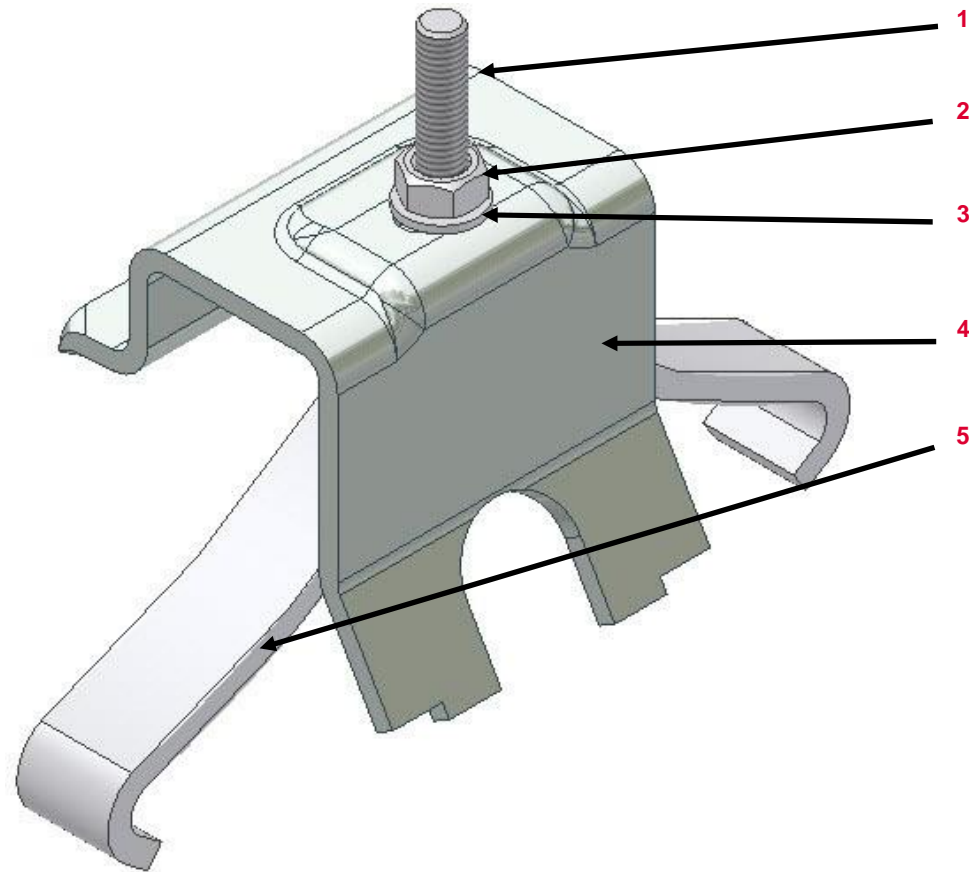

No.	Name 名稱	Article number 品項編號
1	Bolt 螺栓	126228
2	Nut 螺母	024090
3	Washer 墊圈	780354
4	Brücke 連接板	721833
5	Hook 鉤子	024040

PERI Rental Criteria 租賃準則



VARIO Accessories

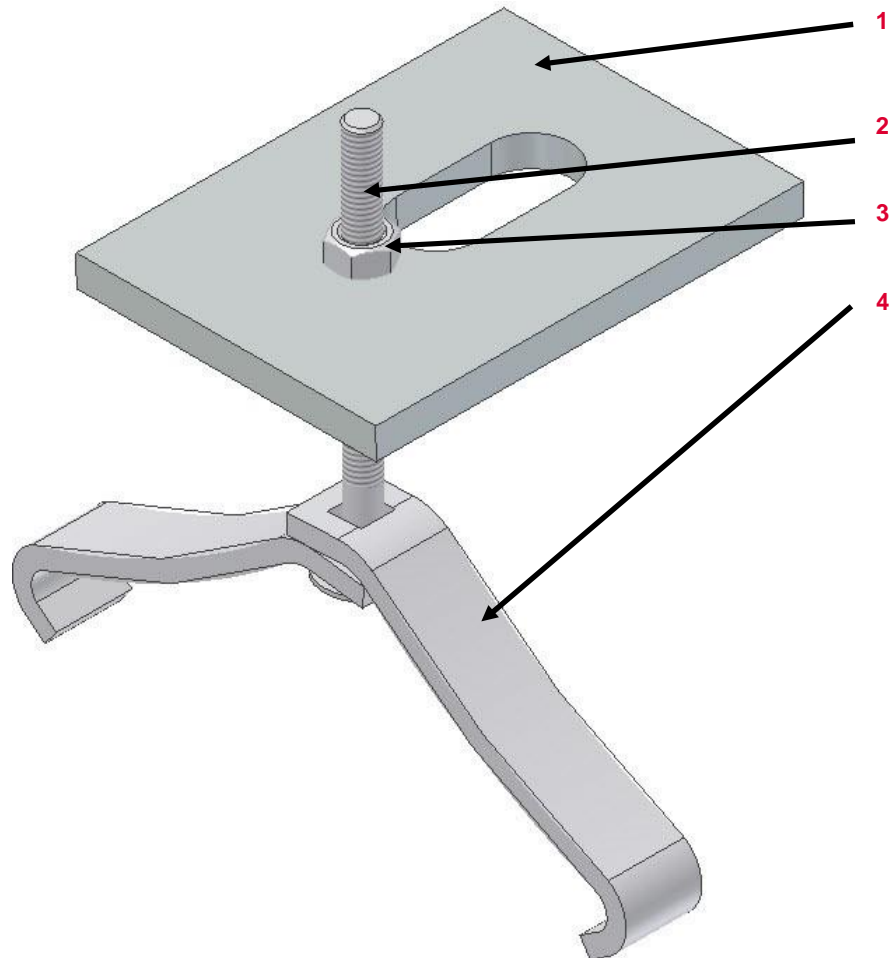

Fix Strap for U100-120, U100-120 固定帶 (024630)



No.	Name 名稱	Article number 品項編號
1	Pressure plate 壓力板	722670
2	Bolt 螺栓	710249
3	Nut 螺母	024090
4	Hook 鉤子	024040

T20 吊鉤帶 (024880) 固定帶 (024630)	描述	說明	收費說明	類型
	09.17 Bolt Nut Washer 螺栓 螺母 墊圈			
	<ul style="list-style-type: none"> Missing 遺失 			
	<ul style="list-style-type: none"> Or damaged through force 或受外力破壞 			
	09.18 Hook 鉤子			
	<ul style="list-style-type: none"> Missing 遺失 			
	<ul style="list-style-type: none"> Or damaged through force 或受外力破壞 			
	<ul style="list-style-type: none"> Or soiled 或污損 			

T20 吊鉤帶 (024880) 固定帶 (024630)	描述	說明	收費說明	類型
-------------------------------	----	----	------	----

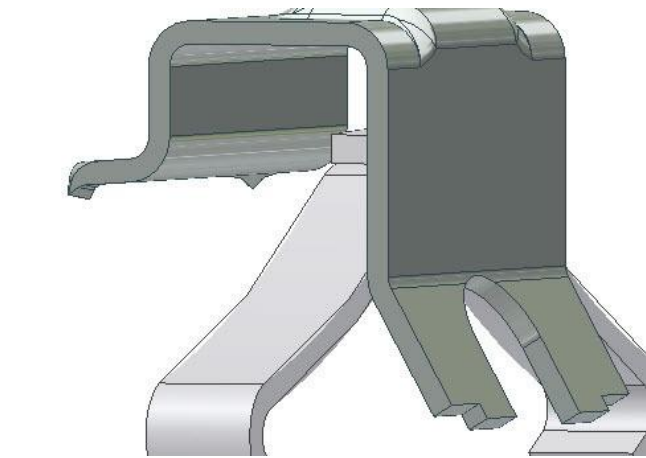

09.19 „Brücke“ bent
連接板彎曲

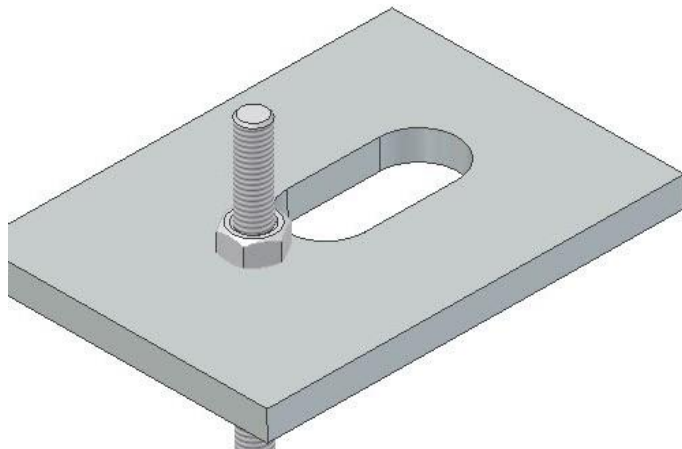

09.20 Pressure plate 壓力板

■ Bent 彎曲



■ Or Missing 或遺失



PERI Rental Criteria 租賃準則







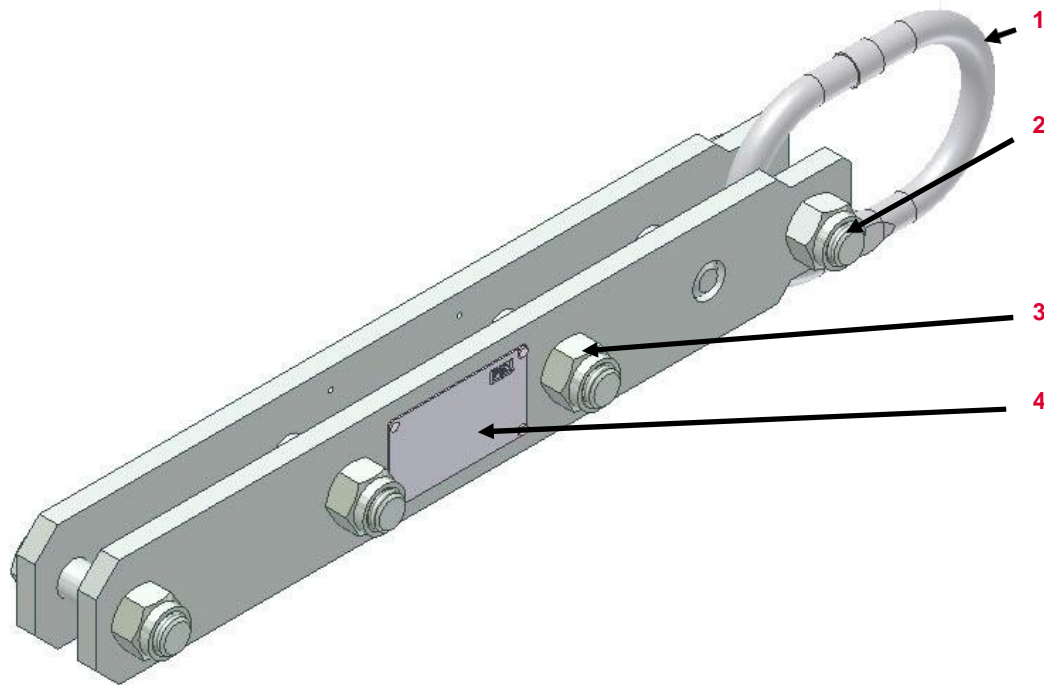



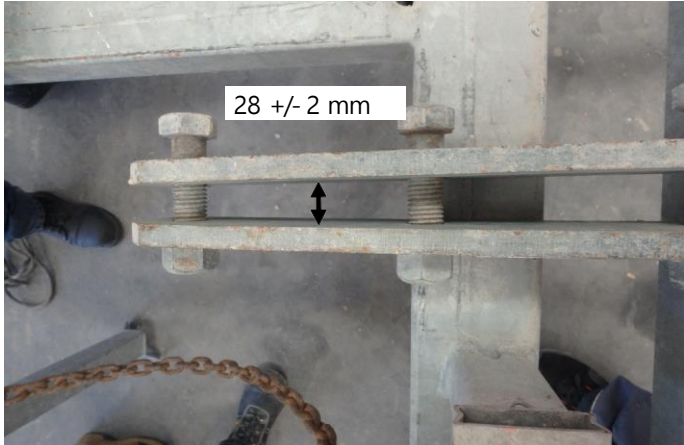



VARIO Accessories



Crane Hook-2 VT20, 木樑 VT20 吊鉤-2 (113712)



No.	Name 名稱	Article number 品項編號
1	Suspension Link 減震連接環	106894
2	Bolt 螺栓	024900
3	Nut 螺母	781053
4	Type plate 規格板	113721

Crane Hook-2 VT20, 木樑 VT20 吊鉤-2 (113712)	描述	說明	收費說明	類型
	09.21 Bent 彎曲	<ul style="list-style-type: none"> ■ Within the tolerance 在容許範圍內 		
	<ul style="list-style-type: none"> ■ Or out of tolerance and repairable 或超出容許範圍但可修復 			
	<ul style="list-style-type: none"> ■ Or out of tolerance and not repairable 或超出容許範圍且無法修復 			
	09.22 Bolts Nuts 螺栓 螺母	<ul style="list-style-type: none"> ■ Missing 遺失 		
	<ul style="list-style-type: none"> ■ Or damaged through force 或受外力破壞 			

Crane Hook-2 VT20, 木樑 VT20 吊鉤-2 (113712) 描述	說明	收費說明	類型
---	----	------	----

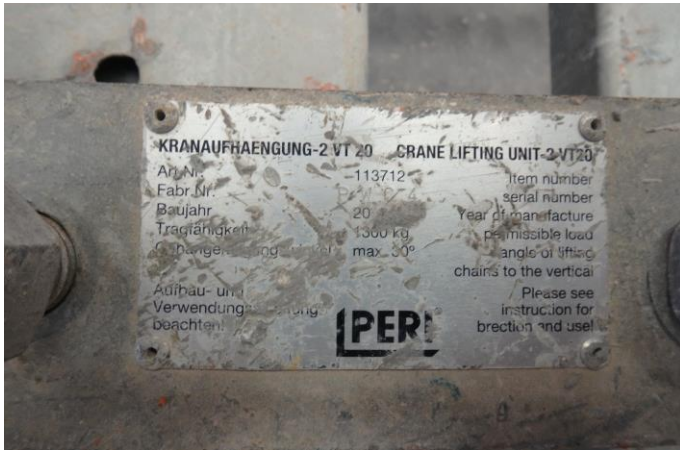

09.23 Type plate 規格板

- Missing 遺失



- Or not readable 或無法辨讀

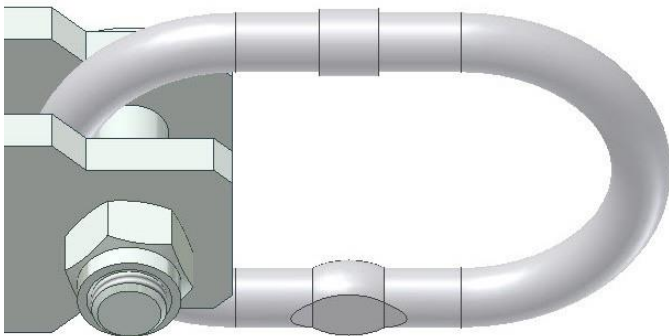

09.24 Suspension Link 減震連接環

- Worn 磨損 ($\varnothing < 9$ mm)



- Or Missing 或遺失



PERI Rental Criteria 租賃準則

VARIO Accessories



Tie Yoke Head SRU, 背撐頭 SRU(110756)

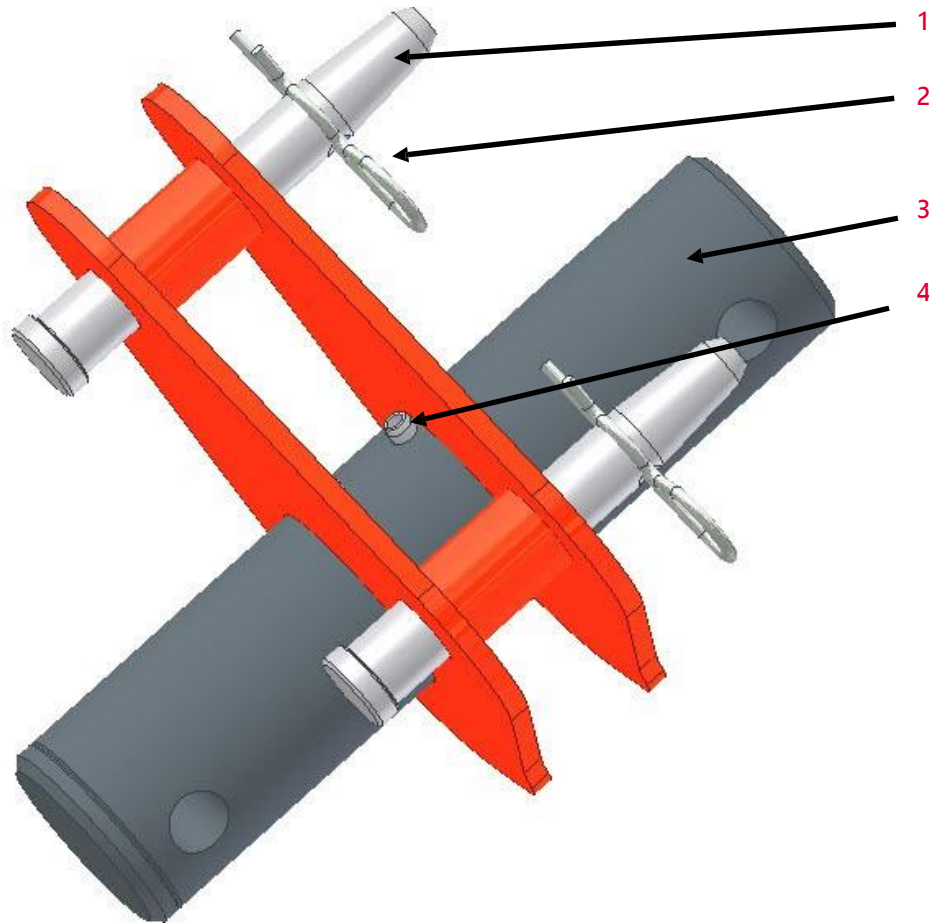













No.	Name 名稱	Article number 品項編號
1	Pin 插銷	105400
2	Cotter pin 開口銷	018060
3	Tie Yoke 背撐管	131352
4	Dowel pin 定位銷	770013

Tie Yoke Head SRU, 背撐頭 SRU (110756)	描述	說明	收費說明	類型	
	09.25 Pin Cotter pin Dowel pin Tie yoke 固定銷 開口銷 定位銷 背撐管	<ul style="list-style-type: none"> Missing 遺失 	 105400 (Pin) 018060 (Spring pin)		
	<ul style="list-style-type: none"> Or damaged through force 或受外力破壞 	 105400 (Pin) 018060 (Spring pin)			
	09.26 Bent 彎曲	<ul style="list-style-type: none"> If possible 如可以修復 			
	<ul style="list-style-type: none"> Or if not possible 如無法修復 				

PERI Rental Criteria 租賃準則

VARIO Accessories



Handrail Holder GT24/VT20, 扶手支架 (101290)	描述	說明	收費說明	類型	
	09.27 Bolt Cotter Pin 螺栓 開口銷	<ul style="list-style-type: none"> Missing 遺失 	 105400 (Bolt) 018060 (Cotter Pin)		
	<ul style="list-style-type: none"> Or damaged through force 或受外力破壞 	 105400 (Bolt) 018060 (Cotter Pin)			
	09.28 Bent 彎曲	<ul style="list-style-type: none"> If possible 如可以修復 			
	<ul style="list-style-type: none"> Or if not possible 如無法修復 				

PERI Rental Criteria 租賃準則

VARIO Accessories









Coupling Compression Plate KDP (024220)	描述	說明	收費說明	類型
壓力連接板 KDP	09.29 Bent 彎曲	 		
				

Extension Splice 24, 延伸件 24 (024480)	描述	說明	收費說明	類型		
	09.30 Bent 彎曲	<ul style="list-style-type: none"> ■ If possible 如可以修復 				
	<ul style="list-style-type: none"> ■ Or if not possible 如無法修復 					
	09.31 Three wingnut 三聯螺母	<ul style="list-style-type: none"> ■ Missing 遺失 		030190 (Three wingnut)		
	<ul style="list-style-type: none"> ■ Or damaged through force 或受外力破壞 		030190 (Three wingnut)			











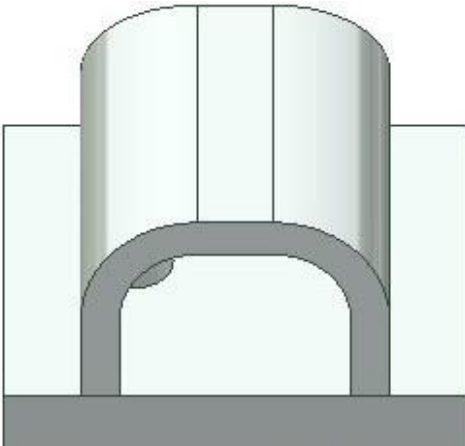

PERI Rental Criteria 租賃準則

VARIO Accessories

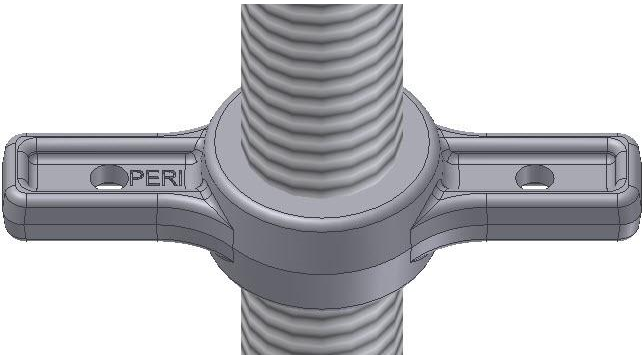

Girder Claw HB, 木樑夾 HB (024600)	描述	說明	收費說明	類型	
	<p>09.32 Bolt Nut Hook 螺栓 螺母 鉤子</p>	<ul style="list-style-type: none"> ■ Missing 遺失 ■ Or damaged through force 或受外力破壞 	<p>  710249 (Bolt)  024090 (Nut)  024040 (Hook) </p> <p>  710249 (Bolt)  024090 (Nut)  024040 (Hook) </p>		
	<p>09.33 Edge Girder Connector Bent 夾具邊緣彎曲</p>	<p>  710968 (Edge Girder Connector) </p>			









Handrail Holder SRU, 扶手支架 SRU (104131)	描述	說明	收費說明	類型		
	09.34 Tube bent 管子彎曲	<ul style="list-style-type: none"> ■ If possible 如可以修復 				
	<ul style="list-style-type: none"> ■ Or if not possible 如無法修復 					
	09.35 Pin Cotter pin 固定銷 開口銷	<ul style="list-style-type: none"> ■ Missing 遺失 		105400 (pin) 018060 (cotter pin)		
	<ul style="list-style-type: none"> ■ Or damaged through force 或受外力破壞 		105400 (pin) 018060 (cotter pin)			

Spindle Head SRU, SRU 調整頭 (109630)	描述	說明	收費說明	類型	
	09.36 Head bent 叉頭彎曲	<ul style="list-style-type: none"> ■ If possible 如可以修復 			
	<ul style="list-style-type: none"> ■ Or if not possible 如無法修復 				
	09.37 Cam nut 凸輪螺母	<ul style="list-style-type: none"> ■ Missing 遺失 			
	<ul style="list-style-type: none"> ■ Or damaged through force 或受外力破壞 				

PERI Rental Criteria 租賃準則

VARIO Accessories



Bulkhead Tie, 隔板螺桿 (013240)	描述	說明	收費說明	類型	
	09.38 Bent 彎曲	<ul style="list-style-type: none"> ■ If possible 如可以修復 			
	<ul style="list-style-type: none"> ■ Or if not possible 如無法修復 				
	09.39 Thread not moveable 螺紋無法移動	<ul style="list-style-type: none"> ■ Worn 磨損 			
	<ul style="list-style-type: none"> ■ Or damaged through force 或受外力破壞 				

PERI Rental Criteria 租賃準則

VARIO Accessories



Lowering Wedge, 降座 (024590; 117930)	描述	說明	收費說明	類型
-------------------------------------	----	----	------	----

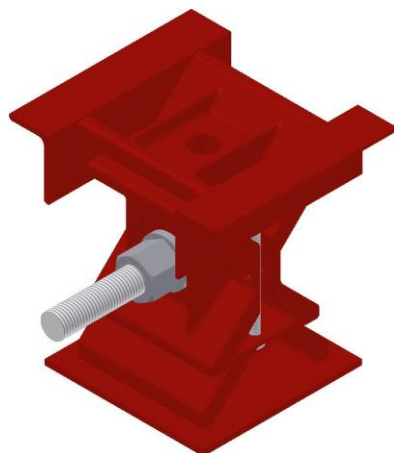

09.40 Function not available
功能無法正常使用

- Worn 磨損
- Or damaged through force
或受外力破壞







09.41 Bent 彎曲

- If possible 如可以修復
- Or if not possible 如無法修復

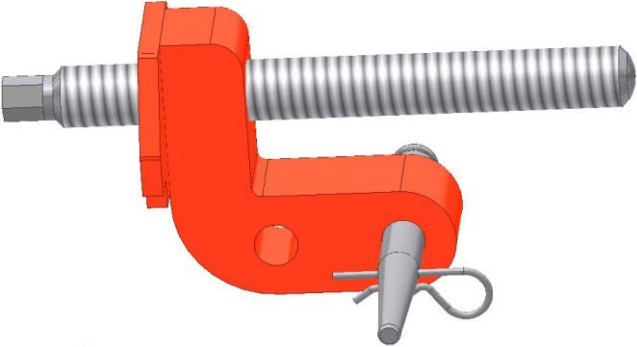

















Errection Bar, 安裝叉 (070740)	描述	說明	收費說明	類型	
	09.42 Bar bent 桿件彎曲	<ul style="list-style-type: none"> ■ If possible 如可以修復 			
	<ul style="list-style-type: none"> ■ Or if not possible 如無法修復 				
	09.43 Complete Errection bar bent 整支安裝叉彎曲	<ul style="list-style-type: none"> ■ If possible 如可以修復 			
	<ul style="list-style-type: none"> ■ Or if not possible 如無法修復 				

Adjusting Unit SRU, 調整元件 SRU (111135)	描述	說明	收費說明	類型	
	09.44 Spindle 叉	<ul style="list-style-type: none"> Worn 磨損 	 111132 (Spindle)		
	<ul style="list-style-type: none"> Or damaged through force 或受外力破壞 	 111132 (Spindle)			
	09.45 Pin Cotter pin 開口銷 固定銷	<ul style="list-style-type: none"> Missing 遺失 	 104031 (Pin) 018060 (Cotter pin)		
	<ul style="list-style-type: none"> Or damaged through force 或受外力破壞 	 104031 (Pin) 018060 (Cotter pin)			

PERI Rental Criteria 租賃準則

Glossary Icons 圖示對照表



圖示	含意	圖示	含意	圖示	含意
	Not OK – Scrap 材料需報廢		Compensation (customer) 客戶需賠償		Optical damage – it's permitted to handle out 可見的損壞 · 可以被修復或處理
	OK— Article stays in Rental Park 材料仍在可租賃使用的範圍		No compensation 無需賠償		Functional damage – it's permitted to handle out 功能損壞 · 可以被修復或處理
	It's not permitted to handle out the article because of security aspects 因安全考量無法再交付 · 材料需報廢		Shorten the article 需裁短材料		Functional damage– it's not permitted to handle out 功能損壞 · 無法被修復或處理
	Repair according to Working Instruction 材料需依指示修復		Mark article 需在材料上標記		Statical damage– it's not permitted to handle out 物理損壞 · 無法再使用
	Fix article cold 材料需修復		Replace defect components 需替換損壞零件		
	Repair after local profitability calculation 需在計算當地利潤後修復		Replace missing components 需替換遺失零件		
	Clean the article 材料需清潔				